

ILUMIA™

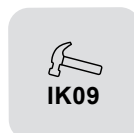

Power Tunable LED UFO Highbay Light

Product Appearance

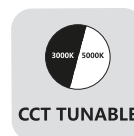

Product Features

- 1. DIP Switch: 3 different Power Tunable
- 2. Certification: UL, DLC
- 3. Color: black
- 4. Wire length: 6FT
- 5. Workable height: 6M-12M
- 6. Lighting angle: 60°, 90°, 120° optional
- 7. Accessories: photocell sensor, photocell sensor + microwave sensor, emergency backup battery, reflector optional
- 8. With high transmittance of PC lens
- 9. Die-casting radiator with excellent heat dissipation, overall powder-coated and through 2000hrs' salt spray testing
- 10. Using the appropriate water-proof connector and silicone ring to seal, protecting level reaching IP65, suitable for different kinds of outdoor harsh working environment.

Product Dimension

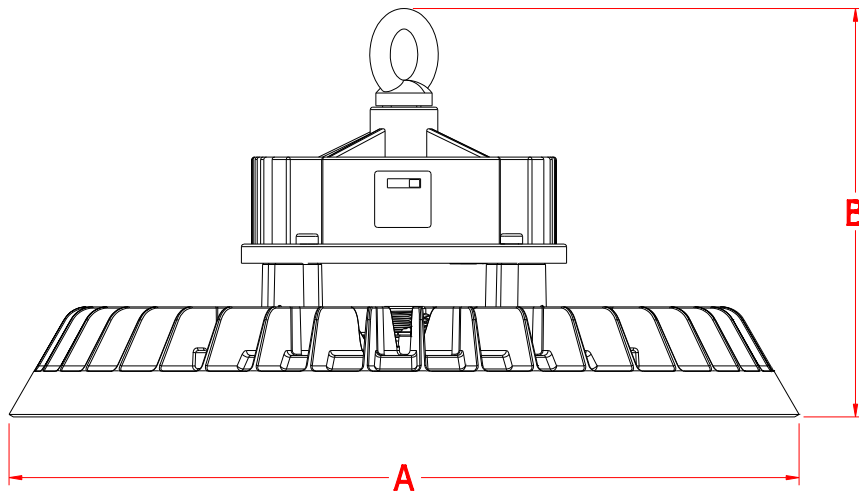

| Model | A (inch)(mm) | B (inch)(mm) |
|-------|--------------------|-------------------|
| | 253mm (9.96") | 154mm (6.06") |
| | 308mm (12.13") | 160mm (6.30") |
| | 308mm (12.13") | 160mm (6.30") |
| | 354mm (13.94") | 165mm (6.50") |

Specification

| Model | Power | Input Voltage | Dimmable | Lumens | Luminous Efficiency | PF | Ra | CCT |
|------------------|-------|---------------|----------|-----------|---------------------|------|----|-------------|
| Standard Version | 100W | AC100-277 | 0-10V | 17,000 lm | 170lm/w | >0.9 | 80 | 4000K-5700K |
| Standard Version | 150W | AC100-277 | 0-10V | 25,500 lm | 170lm/w | >0.9 | 80 | 4000K-5700K |
| Standard Version | 200W | AC100-277 | 0-10V | 34,000 lm | 170lm/w | >0.9 | 80 | 4000K-5700K |
| Standard Version | 240W | AC100-277 | 0-10V | 40,800 lm | 170lm/w | >0.9 | 80 | 4000K-5700K |

GENERAL INFORMATION

| | |
|------------------|---|
| Driver included | Yes |
| CE mark | Yes |
| RoHS compliant | Yes |
| Safety features | Open circuit protection Short circuit protection Overvoltage protection |
| Testing standard | LM-79-19(all measurements in ISO17025 accredited laboratory) |

HOUSING AND FINISH

| | |
|--------------------|--|
| Housing | Aluminium |
| Optic | Polycarbonate |
| Protector | Polycarbonate (with integrated lenses) |
| Housing finish | Electrostatic polyester powder coating |
| Standard colour(s) | RAL 9017 black |
| Tightness level | IP 65 |
| Impact resistance | IK 09 |

OPERATING CONDITIONS

| | |
|----------------------------------|----------------------------------|
| Operating temperature range (Ta) | -30°C to + 45°C |
| Operating Humidity | 10-90%RH |
| Mounting Option | Loop Hanging Bracket Mounting |
| Warranty | 5 years |

Performance

| | |
|---------------------|---------------------|
| Power | 100W/150W/200W/240W |
| Efficacy | 170lm/W |
| Power Efficiency | ≥93% |
| Start Time | ≤0.2S |
| Warm-up time to 60% | 0.5S |

ELECTRICAL INFORMATION

| | |
|---|--|
| Electrical class | Class I EU |
| Nominal voltage | 120-277V 50/60Hz |
| Power factor (at full load) | 0.9 |
| Surge protection options (kV) | 6KV-Line-Line 6KV-Line-Earth |
| Electromagnetic compatibility (EMC) | EN 55015:2019/A11:2020, EN 61000-3-2:2019, EN 61000-3-3:2013, EN 61547:2009, EN 62493:2015 |
| Control protocol(s) | 1-10V, DALI2 (optional) |
| Sensor | Motion sensor (optional) |
| Emergency | Optional auxiliary battery |
| Total Harmonic Distortion(THD) | IEC 61000-3-2 Class C <20% |
| Driver Type | Constant current(CC) |
| For fixed Class 1 luminaires, overvoltage protective devices which comply with IEC 61643-11 shall be disconnected from the circuit. | |
| withstand voltage | 1.5KV 60S 10mA |

OPTICAL INFORMATION

| | |
|----------------------------------|---------------------------------------|
| LED Type | SMD2835 |
| Beam Angle | 60° / 90° / 120° |
| Recommended installation height | 4m to 12m |
| Color Tolerance | Ra70 ≤7 Ra80 ≤5 |
| LED colour temperature | 3000K / 4000K / 5000K / 5700K / 6500K |
| Colour rendering index (CRI) | CRI>70 standard CRI>80 optional |
| Upward Light Output Ratio (ULOR) | 0% |

※Ra measurement tolerance is ±2.

LIFETIME OF THE LEDS @ TA 25°C

| | |
|--------------------|----------------|
| All configurations | |
| L70B10 | >100,000h |
| L80B10 | >50,000h |
| L90B10 | >30,000h |
| Switching Cycles | >100,000 times |

Light Distributions

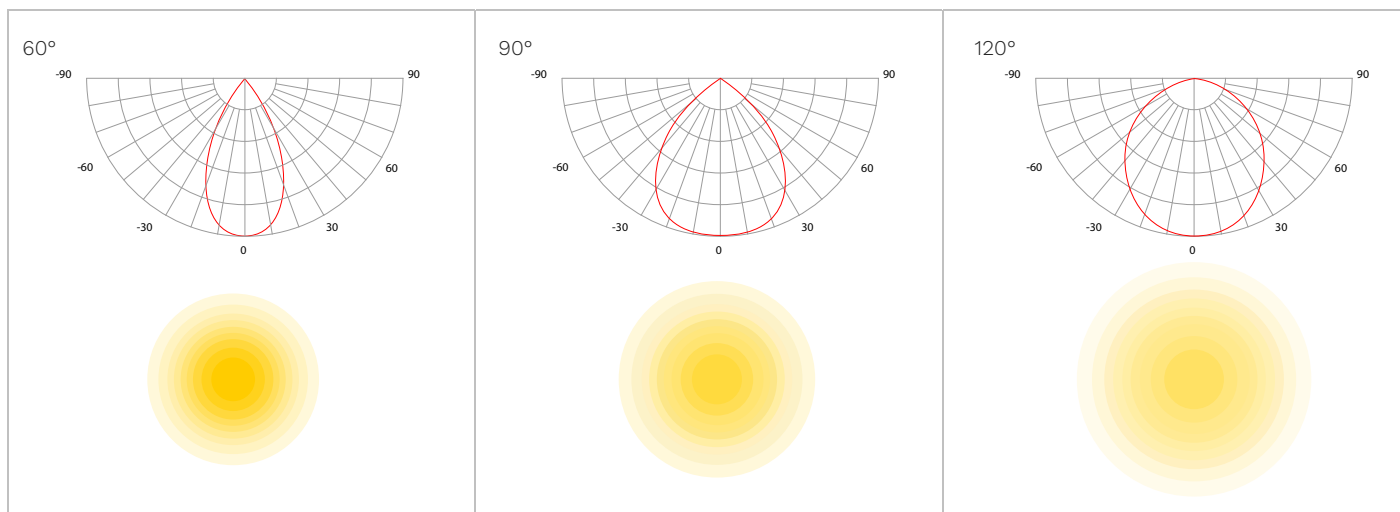

Optional Accessories

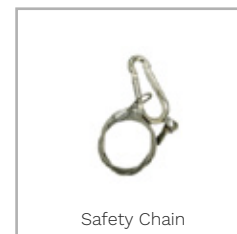
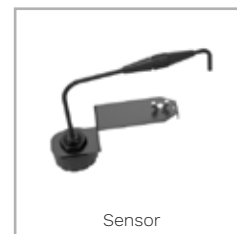
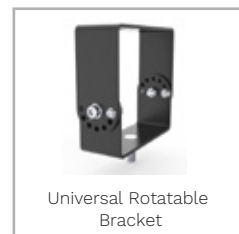

Product dimensions

100W

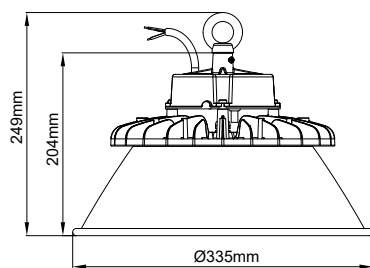
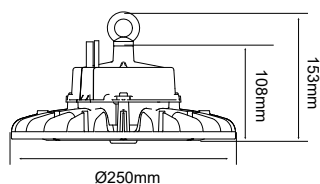

Universal Reflector

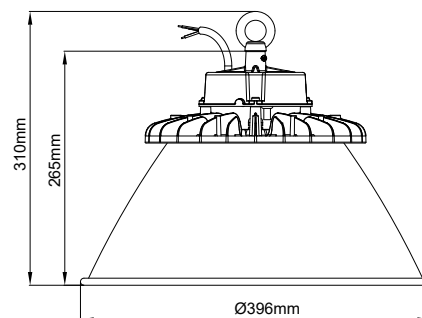

Tall Reflector

150W

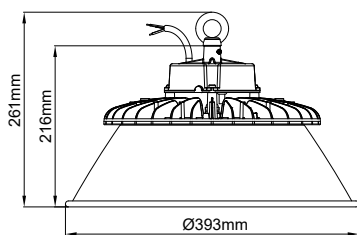
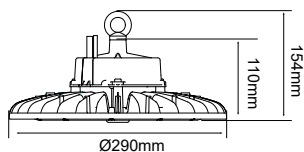

Universal Reflector

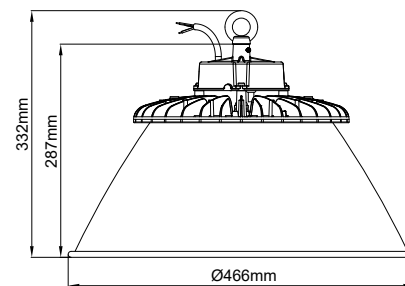

Tall Reflector

200W

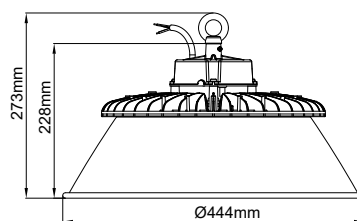
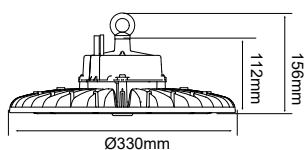

Universal Reflector

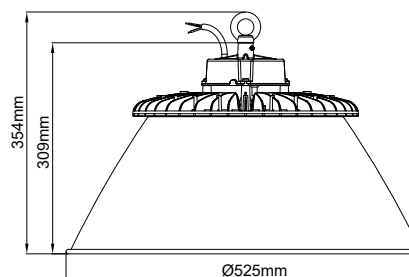

Tall Reflector

240W

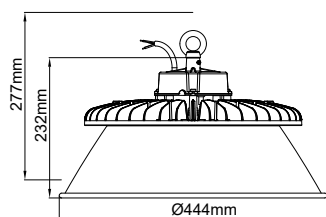
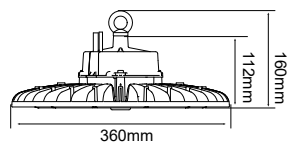

Universal Reflector

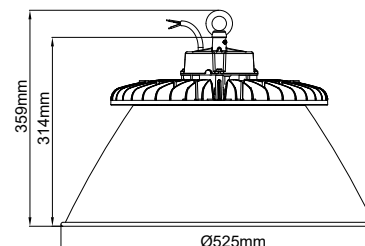

Tall Reflector

Packaing

PACKAGING

| POWER | PACKAGE SIZE | QTY/CTN | SINGLE PIECE VOLUME | NET WEIGHT | GROSS WEIGHT | 20GP | 40HQ |
|-------|------------------|----------|----------------------|------------|--------------|---------|---------|
| 100W | L300*W300*H160mm | 1PCS/CTN | 0.0144m ³ | 1.7kg | 2.3kg | 2280pcs | 5168pcs |
| 150W | L350*W350*H160mm | 1PCS/CTN | 0.0196m ³ | 2.0kg | 2.7kg | 1550pcs | 3520pcs |
| 200W | L380*W380*H165mm | 1PCS/CTN | 0.0238m ³ | 2.4kg | 3.2kg | 1350pcs | 3003pcs |
| 240W | L410*W410*H170mm | 1PCS/CTN | 0.0286m ³ | 2.9kg | 3.8kg | 1064pcs | 2369pcs |

2280_{PCS}
100W/20GP

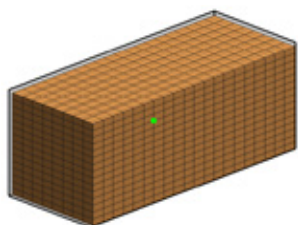

5168_{PCS}
100W/40HQ

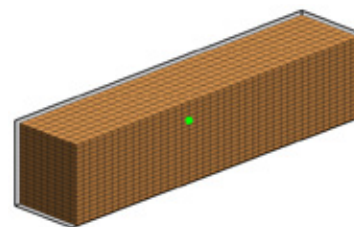

1550_{PCS}
150W/20GP

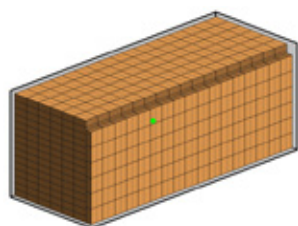

3520_{PCS}
150W/40HQ

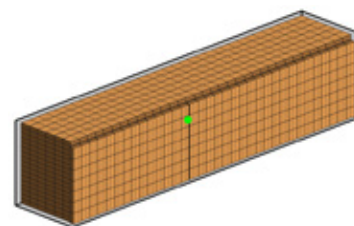

1350_{PCS}
200W/20GP

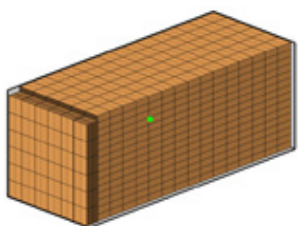

3003_{PCS}
200W/40HQ

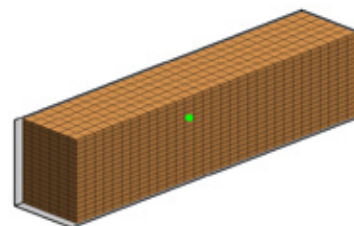

1064_{PCS}
240W/20GP

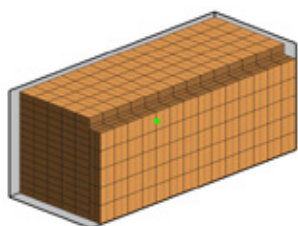

2369_{PCS}
240W/40HQ

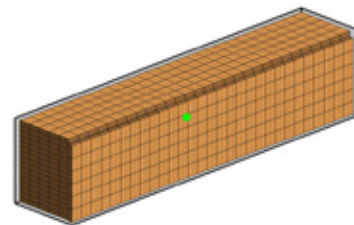

ILUMIATM

Company Name: 4 Winds International LLC

Email: info@4windsi.com

Tel: 346 6315821 / 346 6315824

Web: www.ilumialed.com

Address: 600 Fallbrook Drive Houston, TX 77038